

Smart Kup 82 LED Warm Dim GE

124730XX_124731XX_124732XX

1

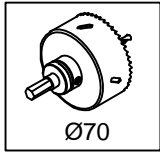
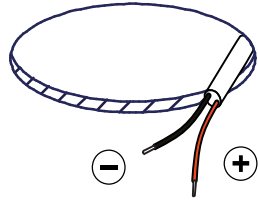

2

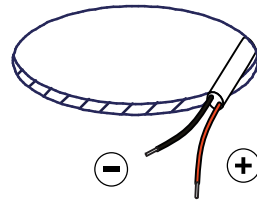

Drive Current (mA)	Forward Voltage		Power (W)
	min (Vf)	max (Vf)	
350	31	36	12

For serial connection, respect polarity!

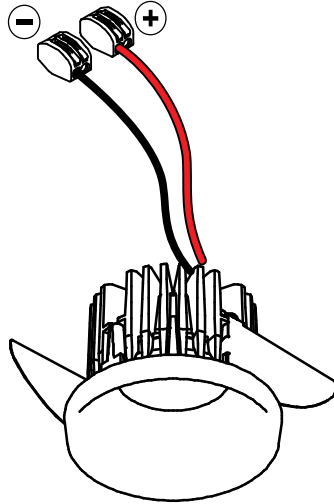

3

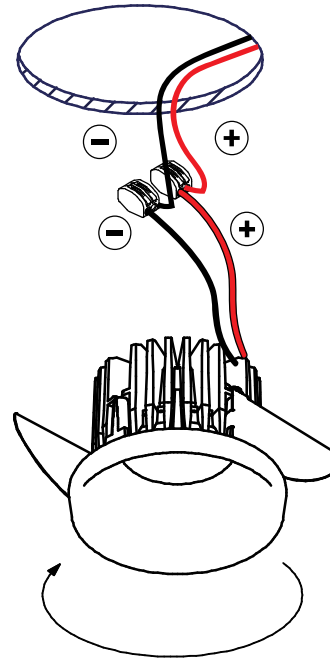

install : Twist clockwise
uninstall : Twist counterclockwise

4

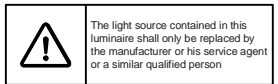
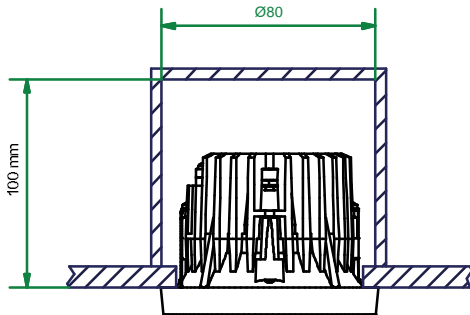
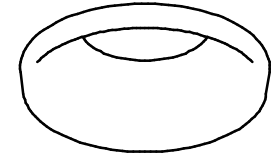

CAN BE USED WITH

Drivers:
see driver matrix - latest version on website
www.supermodular.com or check sales contact

Recessed ring:
12500230 Recessed ring Ø70 H100

Surface box:
125160XX Smart SBS 82 GE for LED
125161XX Smart SBD 82 GE for 2xLED

Gypkit - conbox
12290130 Gypkit 190X190X Ø70
10889830 Conbox outer dim. 190x192x130

Mask:
12500009 Smart Mask 82 1x WhStr
12500032 Smart Mask 82 1x BiStr
12500046 Smart Mask 82 1x Gold
12500109 Smart Mask 82 2Lx WhStr
12500132 Smart Mask 82 2Lx BiStr
12500146 Smart Mask 82 2Lx Gold

